

PatriotTM

DATAMARS

**ELECTRIC FENCE
ENERGIZER**

**USER
GUIDE**



PE2, PE5, PE10



PE5B, PE10B

STOP!

**BEFORE
RETURNING THIS
PRODUCT TO
THE STORE...**

WARNING: READ ALL INSTRUCTIONS

If you suspect that the unit is not working, follow these steps:







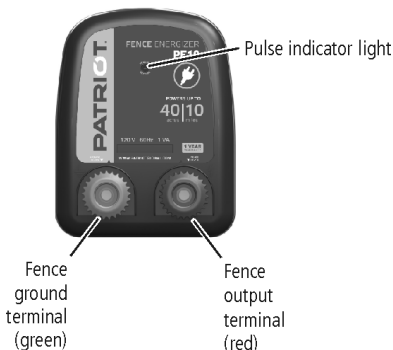

1. Disconnect the unit from the fence.
2. Check that the indicator light is flashing.
3. Check that the voltage between the fence and ground terminals is greater than 4000 V, using a Patriot Digital Voltmeter or Fence Tester.
4. If these tests are OK, you have an installation problem.

Consult your user guide for installation and operating instructions or contact Datamars Customer Service on 800-874-8494.

Patriot PE2, PE5, PE10, PE5B, PE10B



Key to symbols on the unit

-  Fence ground terminal (green). Connect the fence ground terminal to the ground system.
-  Fence output terminal (red). Connect the fence output terminal to the fence.
-  Unit is suitable for connection to AC 120 V.
-  Unit is suitable for connection to DC 6 V/12 V.
-  Risk of electric shock! Do NOT open!
-  Read full instructions before use.
- 
-  Double insulation – no serviceable parts.
-  Do not connect to mains-operated equipment such as battery chargers.

Instructions for PE2, PE5 and PE10



Installation - Indoors/dry locations with AC 120 V line connection

- 1 Mount the unit on a suitable vertical support or wall material using a 3" (75 mm) flat headed nail. Hammer in the nail, allowing it to protrude by 3/8" (10 mm). Slide the unit onto the nail with the nail inside the mounting hole on the back of the unit.
- 2 Connect the Fence ground terminal (green) to a separate ground system that is at least 33' (10 m) away from other ground systems.
- 3 Connect the Fence output terminal (red) to the fence.

Note: If the unit is being mounted on a wall made of concrete, brick, plasterboard or similar, use a screw instead of a nail. A wall anchor or plug may also be required.

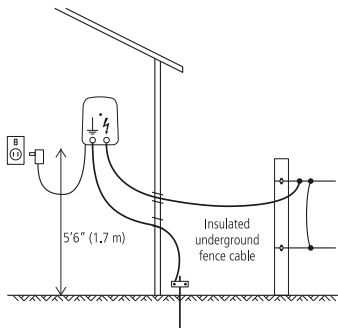

Operation

- 1 Plug the unit into the AC 120 V power supply.
- 2 Turn on the AC 120 V power supply switch.
The pulse indicator light flashes each time the unit pulses.

Instructions for PE5B and PE10B



Installation and operation - DC 6 V/12 V battery connection

- 1 The unit can be mounted directly onto a steel T-post or Y-post using the mounting slot in the case rear. Alternatively, the unit can be mounted onto a wooden post, another suitable vertical support or suitable wall material using a 3" (75 mm) flat headed nail. Hammer in the nail, allowing it to protrude by 3/8" (10 mm). Slide the unit onto the nail with the nail inside the mounting hole on the back of the unit.
- 2 Connect the Fence ground terminal (green) to a separate ground system that is at least 33' (10 m) away from other ground systems.
- 3 Connect the Fence output terminal (red) to the fence.
- 4 Connect the unit to a 6 V/12 V battery using the battery leads. Attach the + (red) clip to the positive terminal of the battery, and the - (black) clip to its negative terminal.

The pulse indicator light flashes each time the unit pulses.

- 5 To prevent damage caused by stock interference and bad weather, house the battery and the unit in protective enclosures.

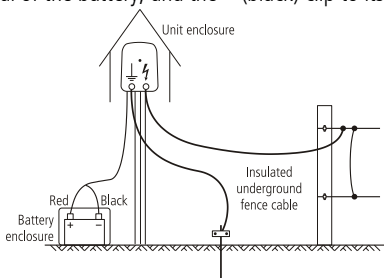

Note: If the unit is being mounted on a wall made of concrete, brick, plasterboard or similar, use a screw instead of a nail. A wall anchor or plug may also be required.

Caution! When connecting the battery, be careful not to short-circuit the supply terminals.

Battery information

Use a 6 V/12 V rechargeable lead-acid battery.

Do not dispose of the battery in a land-fill or in a fire.

In the event of a spill or leakage from a lead-acid battery:

- Contain small spills with dry sand, earth and vermiculite. Do not use combustible materials. If possible, carefully neutralise spilled acid with soda ash, sodium bicarbonate, lime, etc.
- Wear acid-resistant clothing, boots, gloves and a face shield.
- Do not let acid get into the sewerage system.
- Neutralised acid must be managed in accordance with approved local, state and federal requirements. Consult your state environmental agency and/or federal EPA.

Battery charging

Warning!

- Do not attempt to recharge a non-rechargeable battery.
- When recharging a battery, ensure that there is adequate ventilation to allow gases to disperse.
- The battery must be disconnected from the unit before connecting it to a battery charger.

Regular recharging of the battery is essential. Use a suitably rated battery charger and refer to the battery manufacturer's recommendations.

Building an electric fence

Note: This product has been designed for use with electric animal fences.

For information about building an electric fence, refer to the Patriot website patriotglobal.com.

Grounding a fence

All-live fence - For most soil types

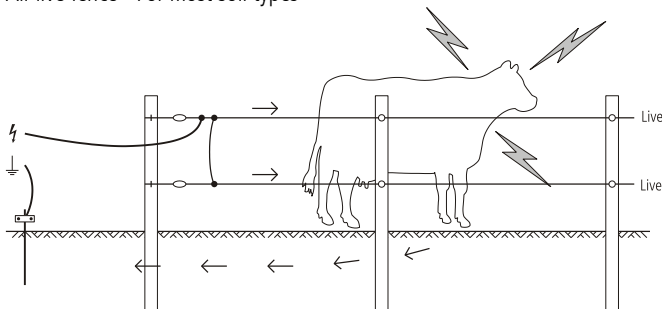

The animal receives a shock when it completes a circuit between the fence and the ground system. The fence above has all live wires and requires conductive soils.

Ground wire return fence - For dry, sandy or frozen ground conditions, where soil conductivity is low.

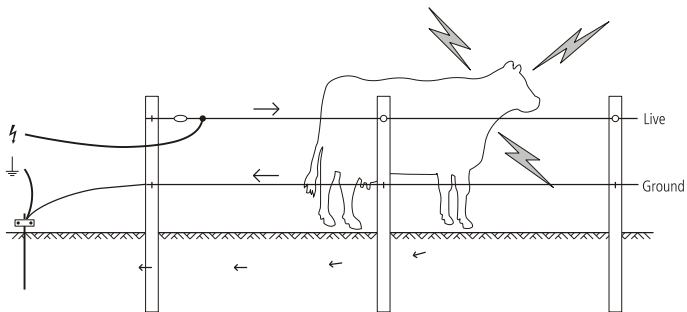

The animal receives a shock when it completes a circuit between a live wire and a ground wire. The fence above has both live wires and ground wires (not insulated to the post). The ground wire is connected back to the grounding system.

Installing a ground system

Select a suitable site for the ground system. The site needs to be:

- At least 33' (10 m) from other ground systems (e.g. telephone, AC 120 V power or the ground system of another unit).
- Away from stock or other traffic that could interfere with the installation.
- At a site that can be easily observed for maintenance.
- Ideally at a site that has damp soil (e.g. a shaded or swampy location).

Note: The site for the ground system does not need to be directly adjacent to where the unit is installed.

Drive a single ground rod into the soil. Use insulated cable to connect the ground rod to the unit's Fence ground terminal. Ensure that there is a good electrical connection at both ends.

Temporary fence construction for DC units only

Temporary fence components

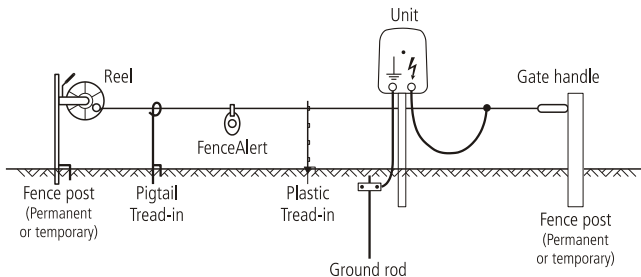

Recommended wire spacing

← 16' (5 m) →

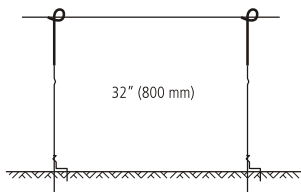

Dairy cattle

← 16' (5 m) →

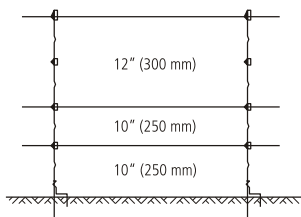

Sheep

← 16' (5 m) →

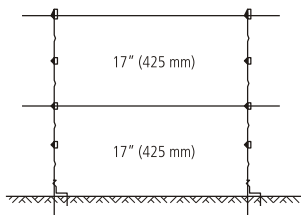

Cattle

Safety considerations

Warning!

- PE5B and PE10B only - Do not connect to AC 120 V operated equipment.
- PE2, PE5 and PE10 only - To reduce the risk of electric shock, the unit has a polarized plug (one blade is wider than the other). This plug will fit in a polarized outlet one way. If the plug does not fit fully in the outlet, reverse the plug. If it still does not fit, contact a qualified electrician to install the proper outlet. Do not change the plug in any way.
- Disconnect the unit from the supply before installation or performing any work on the fence.
- Read all the safety considerations carefully.
- Check your installation to ensure that it complies with all local safety regulations.
- Do not connect simultaneously to a fence and to any other device such as a cattle trainer or a poultry trainer. Otherwise, lightning striking your fence will be conducted to all other devices.

Notes:

- This product has been designed for use with electric animal fences.
 - Keep these instructions in a handy location.
-

Safe electric fence construction

Warning! Read before use.

An electric fence can be hazardous when there is a risk of entrapment or entanglement, or other hazards exist. Serious injury or death may result. Take all steps to avoid the risk of entrapment or entanglement.

Hazards

- ☒ Do not climb through or under an electric fence. If it is necessary to cross an electric fence use a gate or specially designed crossing point.
- ☒ Do not allow young or infirm persons to use this unit without supervision. Do not allow young children to play with this unit or near an electric fence or electrified wires.
- ☒ Do not electrify barbed wire.
- ☒ Do not support off-set electrified wires less than 6" (150 mm) from the vertical plane of a barbed wire fence.
- ☒ Do not electrify any fence construction which could lead to entanglement of persons or animals. We recommend for instance, that no more than one electrified off-set wire be supported on either side of a barbed wire or mesh fence.
- ☒ Do not supply an electric fence from two units.
- ☒ Do not allow electrified wires from two units on the same or adjacent properties to be less than 8' (2.5 m) apart.
- ☒ Do not place the unit's ground electrode within 33' (10 m) of any part of a power supply ground system or telecommunications ground system.
- ☒ Do not run electric fence wires above or close to overhead power or communication lines.

Duty to the public

A warning sign shall be fitted to every point where persons may gain ready access to the conductors.

Where an electric animal fence crosses a public pathway, a non-electrified gate shall be incorporated in the electric animal fence at that point or a crossing by means of stiles shall be provided. At any such crossing, the adjacent electrified wires shall carry warning signs.

Any part of an electric animal fence that is installed along a public road or pathway shall be identified at frequent intervals by warning signs securely fastened to the fence posts or firmly clamped to the fence wires.

- The size of the warning sign shall be at least 4x8" (100x200 mm).
- The background colour of both sides of the warning sign shall be yellow. The inscription on the sign shall be black and shall be either:

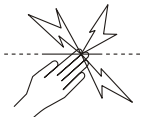

or the substance of "CAUTION: Electric fence".

- The inscription shall be indelible, inscribed on both sides of the warning sign and have a height of at least 1" (25 mm).

Definition of special terms

Unit/Charger/Energizer – An appliance that is intended to periodically deliver voltage impulses to a fence connected to it.

Fence – A barrier for animals or for the purpose of security, comprising one or more conductors such as metal wires, rods or rails.

Electric fence – A barrier which includes one or more electric conductors, insulated from ground, to which electric pulses are applied by a unit.

Ground electrode – Metal structure that is driven into the soil near a unit and connected electrically to the Fence ground terminal of the unit, and that is independent of other grounding arrangements.

Connecting lead – An electric conductor, used to connect the unit to the electric fence or the ground electrode.

Requirements for electric animal fences

Electric animal fences and their ancillary equipment shall be installed, operated and maintained in a manner that minimises danger to persons, animals or their surroundings.

Warning! Avoid contacting electric fence wires especially with the head, neck or torso. Do not climb over, through or under a multi-wire electric fence. Use a gate or a specially designed crossing point.

This unit is not intended for use by persons (including children) with reduced physical, sensory or mental capabilities, or lack of experience and knowledge, unless they have been given supervision or instruction concerning use of the unit by a person responsible for their safety.

Children should be supervised to ensure that they do not play with the unit.

Electric animal fence constructions that are likely to lead to the entanglement of animals or persons shall be avoided.

An electric animal fence shall not be supplied from two separate units or from independent fence circuits of the same unit.

For any two separate electric animal fences, each supplied from a separate unit independently timed, the distance between the wires of the two electric animal fences shall be at least 8' (2.5 m). If this gap is to be closed, this shall be effected by means of electrically non-conductive material or an isolated metal barrier.

Barbed wire or razor wire shall not be electrified by a unit.

A non-electrified fence incorporating barbed wire or razor wire may be used to support one or more off-set electrified wires of an electric animal fence. The supporting devices for the electrified wires shall be constructed so as to ensure that these wires are positioned at a minimum distance of 6" (150 mm) from the vertical plane of the non-electrified wires. The barbed wire and razor wire shall be grounded at regular intervals.

Go to patriotglobal.com for information about grounding.

A distance of at least 33' (10 m) shall be maintained between the unit's ground electrode and any other grounding system connected parts such as the grounding system for the power supply or the telecommunication system.

Connecting leads that are run inside buildings shall be effectively insulated from the grounded structural parts of the building. This may be achieved by using insulated high voltage cable.

Connecting leads that are run underground shall be run in conduit of insulating material or else insulated high voltage cable shall be used. Care must be taken to avoid damage to the connecting leads due to the effects of animal hooves or vehicle wheels sinking into the ground.

Connecting leads shall not be installed in the same conduit as the AC supply wiring, communication cables or data cables.

Connecting leads and electric animal fence wires shall not cross above overhead power or communication lines.

Crossings with overhead power lines shall be avoided wherever possible. If such a crossing cannot be avoided it shall be made underneath the power line and as nearly as possible at right angles to it.

If connecting leads and electric animal fence wires are installed near an overhead power line, the clearances shall not be less than those shown in the table below.

Minimum clearances from power lines for electric animal fences

<u>Power line voltage</u>	<u>Clearance</u>
≤1000 V	10' (3 m)
>1000 V to ≤33,000 V	13' (4 m)
>33,000 V	27' (8 m)

If connecting leads and electric animal fence wires are installed near an overhead power line, their height above the ground shall not exceed 10' (3 m). This height applies to either side of the orthogonal projection of the outermost conductors of the power line on the ground surface, for a distance of:

- 6'6" (2 m) for power lines operating at a nominal voltage not exceeding 1000 V.
- 50' (15 m) for power lines operating at a nominal voltage exceeding 1000 V.

Electric animal fences intended for deterring birds, household pet containment or training animals such as cows need only be supplied from low output units to obtain satisfactory and safe performance.

In electric animal fences intended for deterring birds from roosting on buildings, no electric fence wire shall be connected to the unit's ground electrode.

Ensure that all line-operated, ancillary equipment connected to the electric animal fence circuit provides a degree of isolation between the fence circuit and the supply mains equivalent to that provided by the unit.

Protection from the weather shall be provided for the ancillary equipment unless this equipment is certified by the manufacturer as being suitable for use outdoors.

Servicing

This product is NOT serviceable. Please refer to the warranty conditions at patriotglobal.com.









ATTENTION ! Lire toutes les Instructions

-  Consultez nuestra página web patriotglobal.com para acceder a las instrucciones completas de instalación y funcionamiento.

¡ADVERTENCIA! Lea todas las Instrucciones

-  Pour les instructions complètes d'installation et d'utilisation, veuillez vous reporter à notre site web patriotglobal.com.

Explication des symboles sur l'électrificateur

-  Borne de terre de la clôture (vert). Connectez la borne de terre au système de mise à la terre de l'électrificateur.
-  Borne de sortie vers la clôture (rouge). Connectez la borne de sortie à la clôture.
-  Cet électrificateur est conçu pour être utilisé avec du courant alternatif de 120 V.
-  Cet électrificateur est conçu pour être utilisé avec du courant continu de 6 V et 12 V.
-  Risque de choc électrique ! Ne pas ouvrir !
CAUTION
-  Lire attentivement toutes les instructions avant usage.
- 
-  Double isolation : ne contient pas de pièces réparables.
-  Ne jamais raccorder cet appareil à des équipements alimentés par le réseau électrique, tels que des chargeurs de batterie.

Attention !

- Ne jamais charger une batterie non rechargeable.
- Pendant le chargement de la batterie, assurer une ventilation adéquate pour permettre aux gaz de se dissiper.
- La batterie doit être déconnectée de l'électrificateur avant sa connexion à un chargeur.

Attention !

- PE5B et PE10B uniquement - Ne jamais raccorder cet appareil à des équipements alimentés par le réseau électrique.
- PE2, PE5 et PE10 uniquement - Pour réduire le risque d'une secousse électrique, l'unité a une fiche polarisée (une lame est plus large que l'autre). Cette fiche ne rentre dans une prise polarisée que dans un sens. Si la fiche ne rentre pas entièrement dans la prise, retournez la fiche. Si elle ne rentre toujours pas, contactez un électricien qualifié pour installer la bonne prise. Ne modifiez pas la fiche.
- Déconnectez l'unité du système d'alimentation électrique avant de procéder à tout travail d'installation ou toute autre intervention sur la clôture.
- Lisez attentivement toutes les règles de sécurité.
- Vérifiez soigneusement que votre clôture est en conformité avec tous les règlements locaux de sécurité.
- Ne raccordez jamais un électrificateur simultanément à une clôture et à un autre appareil tel qu'un système de dressage de bétail ou de volaille. Sinon, la foudre pouvant tomber sur votre clôture risque de s'étendre à tous les autres appareils.

Notes :

- Ce produit a été conçu pour une utilisation avec des clôtures électriques pour animaux.
 - Gardez ces instructions à un endroit pratique.
-

Installation d'une clôture électrique sûre

Attention ! Lisez avant utilisation.

Une clôture électrique peut être dangereuse si elle présente un risque d'embrouillement ou d'emmêlement ou que d'autres risques existent. Des blessures graves ou la mort peuvent en être la conséquence. Prenez les mesures nécessaires pour éviter tout risque d'embrouillement ou d'emmêlement.

Dangers

- Ne passez pas par-dessus ou par-dessous une clôture électrique. Si vous devez traverser une clôture électrique, utilisez une porte ou un passage spécialement aménagé.
- Ne permettez jamais aux enfants ou à des personnes ayant une quelconque infirmité d'utiliser cet appareil sans supervision. Ne laissez jamais jouer un enfant avec cet appareil ou à proximité d'une clôture électrique ou d'un fil électrifié.
- N'électrifiez jamais des fils barbelés.
- Ne jamais électrifier des fils montés en parallèle d'une clôture de fil de fer barbelé et se trouvant à moins de 6" (150 mm).
- N'électrifiez jamais une clôture qui pourrait entraîner un risque d'emmêlement pour l'homme ou les animaux. Nous vous recommandons, par exemple, de n'installer qu'un seul fil décalé électrifié par côté d'un fil barbelé ou d'un grillage.
- N'alimentez jamais une clôture électrique par deux électrificateurs.
- Assurez toujours une distance d'au moins 8' (2,5 m) entre des fils électrifiés de deux appareils sur le même lotissement ou un lotissement voisin.
- Ne mettez jamais la prise de terre de l'électrificateur à moins de 33' (10 m) de toute partie d'une prise de terre d'un réseau électrique ou de lignes de télécommunication.
- N'installez jamais des fils de clôture électrique au-dessus ou près de lignes électriques ou de télécommunication aériennes.

Obligation envers le public

Une plaque de signalisation doit être mise en place partout où des personnes auront accès aux conducteurs.

Partout où une clôture électrique pour animaux croise un chemin public, une porte non électrifiée sera incorporée à la clôture électrique pour animaux ou bien un passage au moyen d'une échelle sera prévu. Les fils électrifiés adjacents à ces passages doivent être munis de plaques de signalisation.

Toute partie d'une clôture électrique pour animaux installée le long d'une voie publique ou d'un sentier sera signalée à des intervalles fréquents par des plaques de signalisation qui seront solidement attachées aux piquets ou accrochées à la ligne de clôture.

- La taille des plaques de signalisation sera au moins de 4x8" (100x200 mm).
- La couleur de fond des plaques doit être jaune des deux côtés. L'inscription sur la plaque doit être en noir et soit indiquer le symbole ci-dessous :

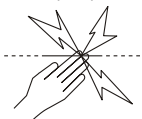

soit indiquer en substance « ATTENTION : Clôture électrique ».

- L'inscription doit être ineffaçable, inscrite sur les deux côtés de la plaque de signalisation et avoir une hauteur minimale de 1" (25 mm).

Définitions des termes techniques

Électrificateur de clôture : appareil émettant régulièrement des impulsions électriques à la clôture connectée à l'électrificateur.

Clôture : une barrière utilisée pour contenir des animaux ou pour des raisons de sécurité qui comprend une ou plusieurs conducteurs tels fils métalliques, piquets ou lattes.

Clôture électrique : une barrière comprenant un ou plusieurs conducteurs électriques, isolée de la terre et soumise à des impulsions électriques générées par un électrificateur.

Prise de terre : structure métallique enfoncée dans le sol à proximité d'un électrificateur et connectée électriquement à la borne de terre de l'électrificateur, structure séparée de tout autre système de mise à la terre.

Fil de connexion : un conducteur électrique, utilisé pour relier l'électrificateur à la clôture électrique ou à la prise de terre.

Warranty

This warranty does not cover defects caused by:

- Incorrect input voltage or polarity
- Damage to external wiring
- Physical mishandling
- Water immersion
- Vermin or insect damage

This warranty covers defects caused by lightning.

Note: This product has been manufactured to comply with international safety standards.







This product is warranted against faulty material and workmanship for a period of 2 years FROM DATE OF PURCHASE.

If a warranted defect occurs, return this product with proof of purchase to an authorised service centre. For details, see patriotglobal.com

Note:

- No responsibility is accepted for any accident or damage caused subsequent to any tampering with or modification to or misuse of this product, including (but not limited to) alterations made by anyone other than Datamars or its agents.
 - To the maximum extent permitted by law, this warranty is exclusive, personal to you and in lieu of all other warranties, representations or conditions relating to this product (whether express or implied and whenever arising) whether originating by statute, law, trade, custom or otherwise.
 - The product warranty is only valid in the original country of purchase. Any claims made in another country may incur full repair costs at the owner's expense.
-

RECOMMENDATIONS

	PE2	PE5	PE10	PE5B	PE10B
	✓	✓	✓	✓	✓
	✓	✓	✓	✓	✓
	✓	✓	✓	✓	✓
	✓	✓	✓	✓	✓
		✓	✓	✓	✓
		✓	✓	✓	✓
		✓	✓	✓	✓

FOR USE WITH:

STEEL WIRE	✓
ALUMINUM WIRE	✓
POLIWIRES / POLIROPE	✓
POLI TAPE	✓

SAVE THESE INSTRUCTIONS