

USER MANUAL

20, 36, 63 J Mains Energizer

Contents

Electric fencing and your energizer.....	1
Parts of the energizer	2
Installation.....	2
Operation	2
The Remote Control Handset.....	3
Communication between the energizer and a Remote Control Handset.....	4
Building a permanent electric fence	5
Safety considerations.....	7
Frequently asked questions/Troubleshooting	8
Servicing	9
Product specifications.....	10



WARNING: READ ALL INSTRUCTIONS

© 2003-2010 Tru-Test Limited

All product names and brand names in this document are trademarks or registered trademarks of their respective holders.

No part of this publication may be photocopied, reproduced, stored in a retrieval system, or transmitted in any form or by any means, electronic, mechanical, photocopying, recording or otherwise without the prior written permission of Tru-Test Limited. Product specifications may change without prior notice.

For more information on other quality Tru-Test Group brands and products, visit www.tru-test.com.

Tru-Test Limited
25 Carbine Road
Mt Wellington
Auckland 1060
New Zealand

Postal address:
P O Box 51078
Pakuranga
Manukau 2140
New Zealand



815040 Issue 1 05/2010

Tru-Test Ltd thanks the International Electrotechnical Commission (IEC) for permission to reproduce information from its International Publication 60335-2-76 ed.2.0 (2002). All such extracts are copyright of IEC, Geneva, Switzerland. All rights reserved. Further information on the IEC is available from www.iec.ch. IEC has no responsibility for the placement and context in which the extracts and contents are reproduced by the author, nor is IEC in any way responsible for the other content or accuracy therein.

Warranty

This product is warranted against faulty material and workmanship for a period from the date of purchase. If a warranted defect occurs, return this product with proof of purchase to the place of purchase. Details of warranty periods and other terms applying are available at the place of purchase or at www.tru-test.com.

Note:

- No responsibility is accepted for any accident or damage caused subsequent to any tampering with or modification to or misuse of this product, including (but not limited to) alterations made by anyone other than Tru-Test Group or its agents.
- To the maximum extent permitted by law, this warranty is exclusive, personal to you and in lieu of all other warranties, representations or conditions relating to this product (whether express or implied and whenever arising) whether originating by statute, law, trade, custom or otherwise.

Electric fencing and your energizer

Congratulations on the purchase of your energizer: This product has been constructed using the latest technology and construction techniques. It has been engineered to give superior performance and many years of service.

It is important to read these instructions carefully and thoroughly. They contain important safety information and will assist you in ensuring that your electric fencing system gives maximum performance and reliability.

Warning!

- USA and Canada - To reduce the risk of electric shock, the energizer has a polarised plug (one blade is wider than the other). This plug will fit in a polarised outlet one way. If the plug does not fit fully in the outlet, reverse the plug. If it still does not fit, contact a qualified electrician to install the proper outlet. Do not change the plug in any way.
- Switch the energizer off before installation or performing any work on the fence.
- Read all the safety considerations carefully. See *Safety Considerations* on page 7.
- Check your installation to ensure that it complies with all local safety regulations.
- The energizer must be located in a shelter, and the cable must not be handled when the temperature is below 5 °C.
- Do not connect simultaneously to a fence and to any other device such as a cattle trainer or a poultry trainer. Otherwise, lightning striking your fence will be conducted to all other devices.

Note:

- This product has been designed for use with electric animal fences.
- Keep this manual in a handy location.

Which energizer do I have?

This user manual covers several models of energizer:

20 J model	820R / 20000R / M20R 820RE / 20000RE / M20RE*
36 J model	835R / 36000R / M36R 835RE / 36000RE / M36RE*
63 J model	63000R / M63R

*These energizers are the European variants of the R energizers.

How does an electric fence work?

An electric fence system comprises an energizer and an insulated fence. The energizer puts very short pulses of electricity onto the fence line. These pulses have a high voltage, but are of very short duration (less than 3/10,000ths of a second). However, a shock from an electric fence pulse is very uncomfortable and animals quickly learn to respect electric fences. An electric fence is not only a physical barrier, but is also a strong psychological barrier.

What are the benefits of an electric fence?

An electric fence has many benefits over conventional fencing:

- Requires less labour and materials to construct.

- Flexibility to change or add paddocks when required. The use of strip grazing techniques can allow temporary fencing to be quickly and easily erected or removed.
- Controls a broader range of animals.
- Minimises damage to expensive livestock when compared with other fencing mechanisms, for example barbed wire.

Parts of the energizer

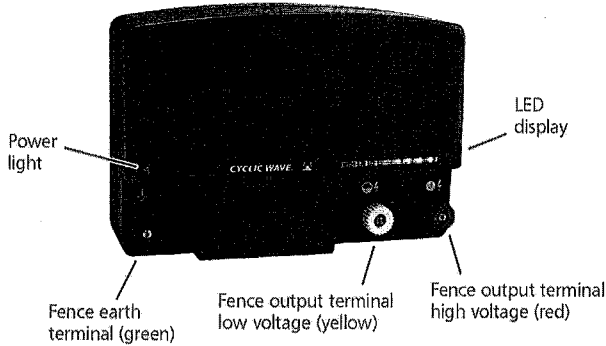

Key to symbols on the energizer



Fence earth terminal. Connect the fence earth terminal to the earth system.



Fence output terminal. Connect the fence output terminal to the fence.



Risk of electric shock! This energizer should be opened or repaired only by qualified personnel.



Read full instructions before use.



This symbol on the product or its packaging indicates that this product must not be disposed of with other waste. Instead, it is your responsibility to dispose of your waste equipment by handing it over to a designated collection point for the recycling of waste electrical and electronic equipment. The separate collection and recycling of your waste equipment at the time of disposal will help conserve natural resources and ensure that it is recycled in a manner that protects human health and the environment. For more information about where you can drop off your waste equipment for recycling, please contact your local city recycling office or the dealer from whom you purchased the product.



The energizer has a double-insulated construction.

Installation

- Mount the energizer close to a power outlet.
- Mount the energizer out of reach of children.
- Use the template printed on the back page of this manual to mount the energizer onto a wall or beam.
- Connect the Fence earth terminal to a separate earth system that is at least 10 m (33') from other earth systems. See *Installing and testing an earth system* on page 6.
- Connect the Fence output terminal to the fence. Use either the low voltage (yellow) or high voltage (red) fence output terminal.

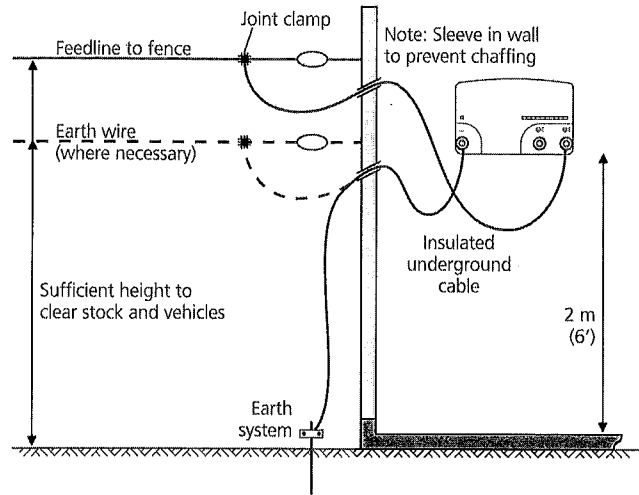

Energizer fence output terminals

The energizer has two Fence output terminals – high voltage (red) and low voltage (yellow). Although the low voltage terminal produces a lower voltage than the high voltage terminal, it *delivers the same amount of energy*.

The low voltage terminal is used in dry areas, where sparks from a higher voltage may cause a fire, or when special fire department regulations are in force. This terminal can also be used to configure a bi-polar fencing system.

Operation

- Turn on the power supply.

Reading voltage

The LED display shows the voltage at the output terminals of the energizer.

When first connected to the power source, all light segments on the LED display illuminate. They then illuminate separately from left to right and back again. This indicates that the energizer is operating normally. The LED display, then, briefly displays a light sequence that identifies the address setting of the energizer.

After three seconds, the energizer starts pulsing. Each of the light segments on the LED display represent an increment of approximately 1 kV (1000 V) of output voltage. For example, if the first 4 segments are illuminated at each pulse, the output voltage is approximately 4 kV (4000 V).

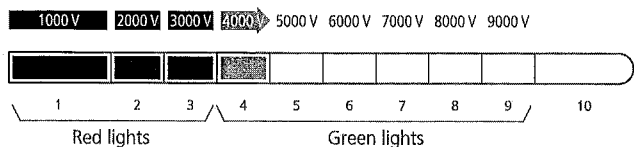

If you see only red lights at each pulse and no green lights, this means that your fence line is very heavily loaded, and you need to look for faults on the fence line. See *Using the fault finder* on page 3.

Full-power mode (36 J and 63 J energizers only)

While the energizer is pulsing, if the large, green light segment on the right is lit up continuously, it is operating in full-power mode. The energizer switches to full-power mode when there is a heavy load on the fence.

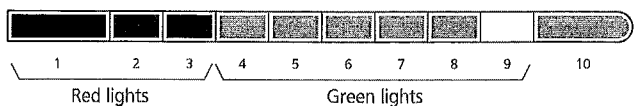

Output power control (63 J energizers only)

The energizer optimises the delivery of output energy to match the fence conditions. For example, if there is a sudden heavy load on the fence (e.g. during heavy rain, or if there are one or more short circuits on the fence), the energizer will progressively increase the output energy in order to maintain the fence voltage. If the load is removed, the energizer re-adjusts the output energy accordingly.

The Remote Control Handset

The Remote Control Handset is three tools in one. It acts as a:

- Remote control – Switching the energizer on or off from a remote location anywhere on the electric fence system
- Fault finder – Assisting in the location of faults anywhere on the fence system
- Volt meter – Providing instant feedback on fence performance (voltage and current)

Parts of the Remote Control Handset

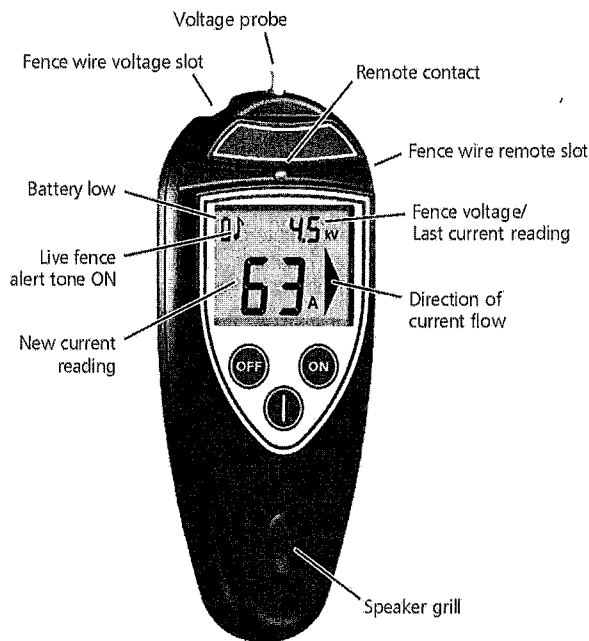

Using the remote control

To turn on the fence:

- 1 Press **ON** to switch on the remote control.
- 2 Insert the fence wire into the Fence wire remote slot, ensuring that the fence wire touches the Remote contact.
- 3 Press **ON** to power the fence. The remote control will beep with each pulse of the energizer.

Tip: If the remote control doesn't work, the fence wire has probably rusted or oxidised. Try rubbing the Remote contact against the fence wire to break through the layer of rust or oxidation.

To turn off the fence:

- 1 Press **ON** to switch on the remote control.
- 2 Insert the fence wire into the Fence wire remote slot, ensuring that the fence wire touches the Remote contact.
- 3 Press **OFF**.

Warning!

- Do not touch the fence until the beeping has stopped.
- The energizer is designed to automatically reactivate following an interruption to the input power supply. This will occur even if it was deactivated using the remote control before the power failed. For this reason, it is strongly recommended that if you are working on a section of fence for an extended period, you should either safely isolate the section with a cut-out switch, or unplug the energizer from the power outlet.

Using the fault finder

Current flows through the path of least resistance. If the fence has a short circuit, more current will flow. Large flows of current load the energizer and fence causing lower voltage readings.

The fault finder is designed to direct the user to the strongest current flow. The current will flow towards a leak much like water draining from a bath and serves as a guide to point to the leak or fault.

Single electric wire

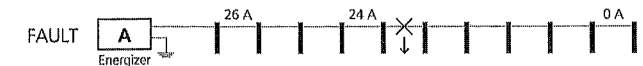

Earth wire return

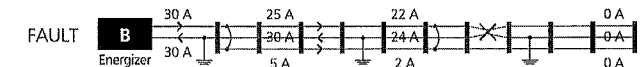
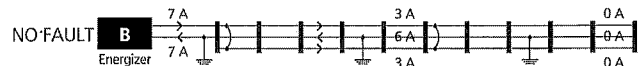

If voltage has dropped on the fence system, it is necessary to identify the cause. (See *Frequently asked questions/Troubleshooting* on page 8.) Possible causes of poor fence performance are short circuits or arcing faults. Location and repair of these faults is often difficult. The fault finding function has been developed to reduce the amount of time spent in locating fence line faults. Regular use of the fault finder will increase your familiarity with the fence system.

Reading the screen

For currents over 1 A (ampere), an arrow appears on the screen next to the current reading showing the direction of the current flow. The arrow always indicates the direction of the strongest current flow. Follow the fence in the direction of the arrow, taking readings at regular intervals. A large drop in the current reading indicates that you've gone past a fault.

When you switch on the fault finder, the last current reading measured will be briefly displayed at the top right of the screen before changing to the fence voltage.

Finding faults

- 1 Start close to where the energizer lead-out wires connect to the fence. Press **ON** to switch on the fault finder.
- 2 Insert the fence wire into the Fence wire voltage slot, ensuring that the fence wire touches the Voltage probe. Note the reading (in amperes).
- 3 Work down the fence line taking readings at regular intervals and at all junction points. The previous reading is displayed briefly at the top right of the screen for comparison.
- 4 At a junction, follow the branch that indicates an abnormally high reading. A sudden reduction in current between one point and the next will indicate the presence of a fault between these two points.
- 5 Move back in the direction of the previous reading until the fault is located.

Notes:

- Higher than normal current readings indicate short circuit faults. Lower than normal current readings with the same voltage readings will most probably indicate arcing faults, a poor connection or broken wire.
- On an earth-wire-return fence, readings taken on the earth wire may not indicate the correct current direction.

Live fence alert tone

When the fence wire is in the Fence wire voltage slot or the Fence wire remote slot, the Remote Control Handset beeps each time the energizer pulses to indicate that the fence is live. The pitch of the alert tone rises with the magnitude of the current pulse. This is particularly useful when measuring currents in different branches at a junction point, and when the display cannot be seen. If the power supply to the fence has been switched off, the Remote Control Handset will not beep.

Enabling and disabling live fence alert tone

- 1 Press and hold **ON**, then press **1** to enter the Set-up mode.
- 2 Press **ON** once to scroll to the flashing note (♪). **OFF** now acts as a toggle to switch the alert tone on or off.
- 3 Do one of the following:
 - To enable the live fence alert tone, press **OFF** until ON appears on the screen.
 - To disable the live fence alert tone, press **OFF** until OFF appears on the screen.
- 4 Press **ON** to move to the next setting.
- 5 Press **1** to switch off the Remote Control Handset.

Backlight

The remote control has a backlight for better screen visibility when there is not enough daylight. If required, this feature can be turned off to conserve battery life.

Enabling and disabling the backlight

- 1 Press and hold **ON**, then press **1** to enter the Set-up mode.
- 2 The backlight option will now be flashing (bl). **OFF** now acts as a toggle to switch the backlight on or off.
- 3 Do one of the following:
 - To enable the backlight, press **OFF** until ON appears on the screen.
 - To disable the backlight, press **OFF** until OFF appears on the screen.
- 4 Press **ON** to move to the next setting.
- 5 Press **1** to switch off the Remote Control Handset.

Battery

The remote control battery must be replaced when you see the  symbol on the screen.

To replace the battery:

- 1 Unscrew the case back.
- 2 Unclip the old battery, and replace with a new PP3, 9 V, alkaline battery.
- 3 Screw the case back into place, taking care not to trap the battery leads under the screws or in the case assembly.

Caring for the Remote Control Handset

- Do not leave the Remote Control Handset in direct sunlight, for instance on a vehicle dashboard.
- Use only a damp cloth to clean the remote control.
- If the Remote Control Handset gets wet, wipe it dry and place it face down to allow any water to run out of the speaker grill. The Remote Control Handset is water-resistant and should require no further attention.

Communication between the energizer and a Remote Control Handset

Understanding address settings

The energizer communicates with a Remote Control Handset using a channel. The channel has a unique address setting.

An energizer supplied with a Remote Control Handset has its address preset to one of 16 possible addresses. The Remote Control Handset is configured to match it.

An energizer supplied without a Remote Control Handset has its address preset to 0 (zero). This means that it will not recognise or act on commands from a remote control.

You may want to change the address setting of your energizer:

- If you buy a Remote Control Handset separately and you want to configure your energizer to accept commands from it.
- If you are using more than one remote-controlled energizer on your property and you want each remote control to operate one energizer only.
- If an adjacent property has an energizer that is operating at the same address setting.
- If your energizer turns off unexpectedly quite often.

A different address setting for each energizer prevents unintentional activation or deactivation of fence lines.

Reading the energizer's address setting

When first connected to the power source, all light segments on the LED display illuminate. They then illuminate separately from left to right and back again. This indicates that the energizer is operating normally. The LED display then displays a light sequence, for three seconds, that identifies the address setting of the energizer.

To identify your energizer's address setting, match the illustration with what you see on the display.

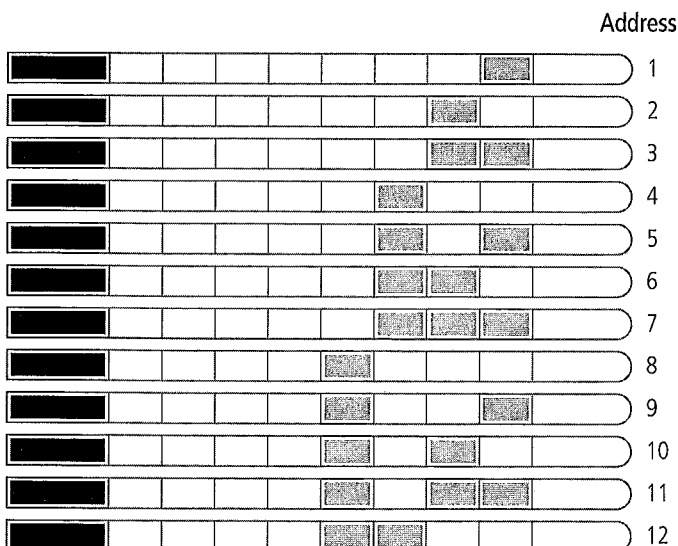

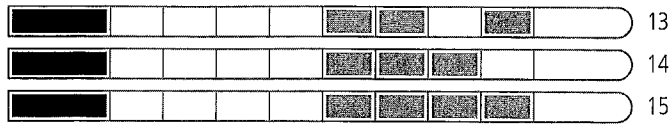

Note: If only the large, red light segment on the left is illuminated, your energizer is set to address zero.

This means that you have an energizer configured to ignore commands from a Remote Control Handset.

Changing the energizer's address setting

To switch to the Standby mode:

- 1 Switch off the power supply to the energizer and wait for 5 minutes, then switch on the power supply again.
- 2 Press **ON** to switch on the remote control.
- 3 Hold the remote control within 150 to 300 mm (6 to 12") of the energizer, then press **OFF**. The energizer will stop pulsing (may take up to 2 seconds) and only the large, green light on the right will continue flashing.
- 4 Press **ON** to switch off the remote control.

To change the energizer's address:

- 1 Switch to the Standby mode. See the procedure above.
- 2 Press and hold **ON**, then press **ON** to enter the Set-up mode.
- 3 Press and hold **ON** to scroll through the list of available options.
- 4 Select the Address (Ad) option, and press **OFF** until the number you want is displayed.
- 5 Hold the remote control within 150 to 300 mm (6 to 12") of the energizer, then press **ON** to transmit the new setting to the energizer.

A moving arrow on the remote control screen indicates that the command is being sent to the energizer. The large, red light on the left of the energizer's LED display illuminates for 6 seconds as the energizer receives the command. The energizer then resumes in Standby mode with only the large, green light on the right flashing.

- 6 Press **ON** to switch off the remote control.

To exit the Set-up mode without changing the energizer's address:

- Instead of pressing **ON**, which transmits the new setting, press **ON**. This switches off the remote control.

Tip: Make a note of the address setting of the energizer to save time should the address be accidentally changed, or if an additional remote control is required in the future.

To reduce the risk of accidental address changes, the energizer has been built with the following safeguards:

- It will accept a new address only *within four minutes* of the power supply being switched on.
- It will accept a new address only when in Standby mode (that is, when the energizer is not pulsing).

Activating the remote control function of an energizer supplied without a Remote Control Handset

An energizer purchased without a Remote Control Handset in the same package will not respond to commands sent by a remote control until the remote control function has been activated in the energizer.

Before activating the remote control function:

- Switch off the power supply to the energizer and wait for 5 minutes, then switch on the power supply again.

To activate the remote control function:

- 1 Press and hold **ON** on the remote control, then press **ON** to enter the Set-up mode.
- 2 Press and hold **ON** to scroll through the list of available options.
- 3 Select the Address (Ad) option, and press **OFF** until the number you want is displayed.
- 4 Hold the remote control within 150 to 300 mm (6 to 12") of the energizer, then press **ON** to transmit the new setting to the energizer.
- 5 Press **ON** to switch off the remote control.

A moving arrow on the remote control screen indicates that the command is being sent to the energizer. The large, red light on the left of the energizer's LED display illuminates for 6 seconds as the energizer receives the command. The energizer then resumes in Standby mode with only the large, green light on the right flashing.

Tip: Make a note of the address setting of the energizer to save time should the address be accidentally changed, or if an additional remote control is required in the future.

Building a permanent electric fence

Components of an electric fence

An electric fence system comprises the following elements:

- *An energizer.*
- *An earth system.* This comprises a number of metal rods inserted into the ground, which are connected to the Fence earth terminal on the energizer.
- *Insulated underground cables.* Used to connect the energizer to the earth and fence.
- *An insulated fence.* Connected to the Fence output terminal of the energizer. Fences can be made to a variety of designs (see below).

Other useful components that can be added:



Cut-out switches. Installed at regular intervals, these allow you to isolate sections of the fence for repair.



Lightning diverter kit. Used to minimise the damage to your energizer from lightning conducted down the fence line.

Typical installation

The animal receives a shock when it completes a circuit between the fence and the earth system. The fence below has all live wires and requires conductive soils. These fences are often referred to as 'all-live' or 'earth-return' fences.

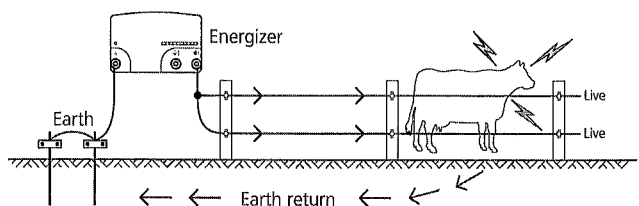

Alternative installation

For soils with poor conductivity (dry, sandy or volcanic), a 'fence-return' or 'earth-wire-return' system may be required in order to get optimum performance from the energizer. On these fences, the Fence earth terminal is connected directly to at least one of the fence wires. The

animal gets maximum shock from touching a live and earth wire at the same time.

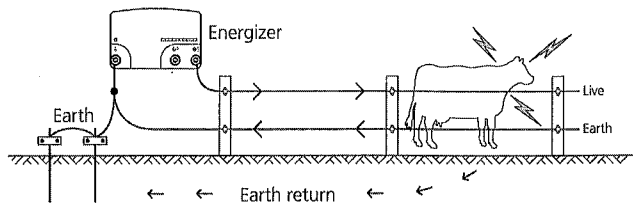

Fence designs

Fences can be constructed to suit the type of livestock and materials available. Discuss with your re-seller which design best suits your needs. Some suggested fence configurations are below.

Cattle and horses

10-15 m (33-49') spacing, posts only

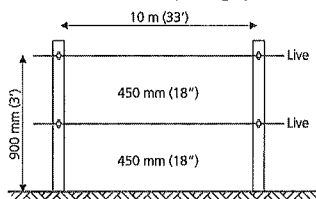

15-20 m (49-65') spacing with droppers

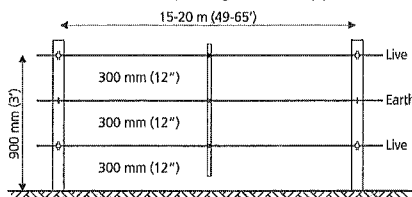

Sheep, goats, cattle and horses

10 m (33') spacing, posts only

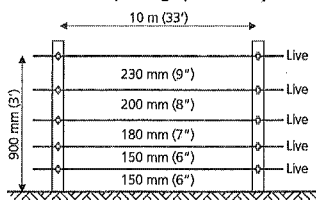

15 m (49') spacing with droppers

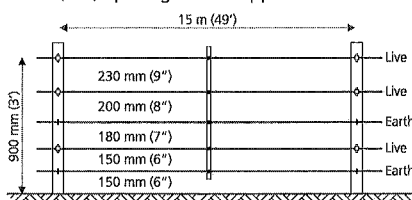

Wild animals

7 wire, 10 m (33') spacing with droppers

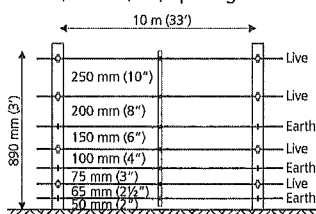

End assemblies

Angle stay

Suitable for field gate, high-tension strainer.

After firmly setting the footed strainer in the ground, dig in the stay block just below ground level, at a distance to ensure the angle stay will be held snugly in position. The stay can be levered into position with a spade.

All-live system

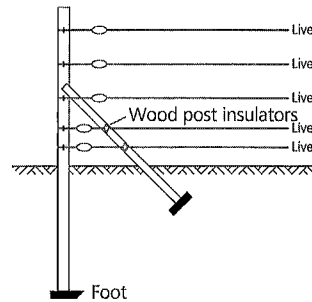

Earth-return system

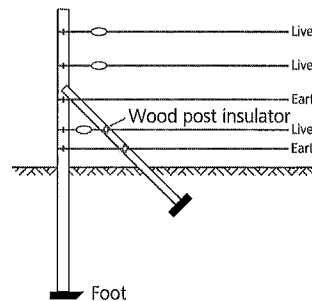

Horizontal stay

Suitable for field gate, high-tension strainer.

Very simple to erect and most suitable as a high tension strainer, excellent in areas where the soil gets very wet or where heavy frost occurs.

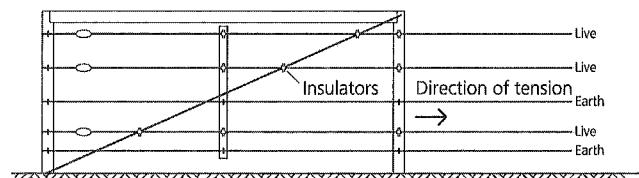

Installing and testing an earth system

Select a suitable site for the earth system. Sites need to be:

- At least 10 m (33') from other earth systems (e.g. telephone, mains power or the earth system from another energizer).
- Away from stock or other traffic that could interfere with the installation.
- At a site that can be easily observed for maintenance.
- Ideally at a site that has damp soil (e.g. a shaded or swampy location). Note that the earth does not need to be directly adjacent to the energizer installation.

Drive earth rods into the ground. Use high-voltage, insulated cable and earth clamps to continuously connect the earth rods and the energizer's Fence earth terminal. Make sure the insulation is stripped back to ensure good contact between the wire and the earth rod.

The number of earth rods used will vary with the soil conditions. For larger energizers, at least six 2 m (6'6") earth rods are required. To ensure that an adequate number of earth rods have been used, test the earth system using the following procedure:

- 1 Turn off the energizer.
- 2 At least 100 m (330') away from the energizer, short circuit the fence by laying several steel rods or lengths of pipe against the fence. For best results, the fence voltage should be lowered to 2000 V or less. In dry or sandy conditions, it may be necessary to drive the rods up to 300 mm (12") into the earth.
Note: It is not acceptable to short circuit a fence return system to the earth wire of the fence.
- 3 Turn the energizer back on.
- 4 Using an electric fence voltmeter, ensure that the fence voltage is below 2 kV.
- 5 *Check your earth system.* Insert the voltmeter's earth probe into the ground at the full extent of the lead, and clip the other lead to the last earth rod. The voltmeter should not read more than 0.3 kV. Anything higher than this indicates that better earthing is required. Either add more earth rods or find a better ground area to drive in the earth rods.

Notes:

- The Remote Control Handset may also be used to check voltage. See *Using the fault finder* on page 3 for more information.
- When earthing energizers located in dairies, earth at least 20 m (65') away from the dairy using double-insulated wire, to avoid touching the dairy building or equipment.

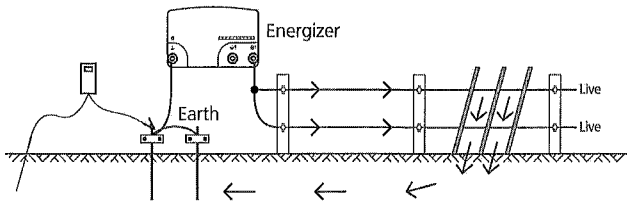

Safety considerations

Definition of special terms

Energizer— An appliance that is intended to periodically deliver voltage impulses to a fence connected to it.

Fence— A barrier for animals or for the purpose of security, comprising one or more conductors such as metal wires, rods or rails.

Electric fence— A barrier which includes one or more electric conductors, insulated from earth, to which electric pulses are applied by an energizer.

Fence circuit— All conductive parts or components within an energizer that are connected or are intended to be connected, galvanically, to the output terminals.

Earth electrode— Metal structure that is driven into the ground near an energizer and connected electrically to the Fence earth terminal of the energizer, and that is independent of other earthing arrangements.

Connecting lead— An electric conductor, used to connect the energizer to the electric fence or the earth electrode.

Electric animal fence— An electric fence used to contain animals within or exclude animals from a particular area.

Electric security fence— A fence used for security purposes which comprises an electric fence and a physical barrier electrically isolated from the electric fence.

Physical barrier— A barrier not less than 1.5 m (5') high intended to prevent inadvertent contact with the pulsed conductors of the electric fence. Physical barriers are typically constructed from vertical sheeting, rigid vertical bars, rigid mesh, rods or chainwire mesh.

Public access area— Any area where persons are protected from inadvertent contact with pulsed conductors by a physical barrier.

Pulsed conductors— Conductors which are subjected to high voltage pulses by the energizer.

Secure area— The side of an electric security fence where a person may come into contact with the electric fence, without the protection of a physical barrier.

Requirements for electric animal fences

Electric animal fences and their ancillary equipment shall be installed, operated and maintained in a manner that minimises danger to persons, animals or their surroundings.

Warning! Avoid contacting electric fence wires especially with the head, neck or torso. Do not climb over, through or under a multi-wire electric fence. Use a gate or a specially designed crossing point.

This energizer is not intended for use by persons (including children) with reduced physical, sensory or mental capabilities, or lack of experience and knowledge, unless they have been given supervision or instruction concerning use of the energizer by a person responsible for their safety.

Children should be supervised to ensure that they do not play with the energizer.

Electric animal fence constructions that are likely to lead to the entanglement of animals or persons shall be avoided.

An electric animal fence shall not be supplied from two separate energizers or from independent fence circuits of the same energizer.

For any two separate electric animal fences, each supplied from a separate energizer independently timed, the distance between the wires of the two electric animal fences shall be at least 2 m (6'6"). If this gap is to be closed, this shall be effected by means of electrically non-conductive material or an isolated metal barrier.

Barbed wire or razor wire shall not be electrified by an energizer.

A non-electrified fence incorporating barbed wire or razor wire may be used to support one or more offset electrified wires of an electric animal fence. The supporting devices for the electrified wires shall be constructed so as to ensure that these wires are positioned at a minimum distance of 150 mm (6") from the vertical plane of the non-electrified wires. The barbed wire and razor wire shall be earthed at regular intervals.

Follow our recommendations regarding earthing. See *Installing and testing an earth system* on page 6.

A distance of at least 10 m (33') shall be maintained between the energizer earth electrode and any other earthing system connected parts such as the power supply system protective earth or the telecommunication system earth.

Connecting leads that are run inside buildings shall be effectively insulated from the earthed structural parts of the building. This may be achieved by using insulated high voltage cable.

Connecting leads that are run underground shall be run in conduit of insulating material or else insulated high voltage cable shall be used. Care must be taken to avoid damage to the connecting leads due to the effects of animal hooves or vehicle wheels sinking into the ground.

Connecting leads shall not be installed in the same conduit as the mains supply wiring, communication cables or data cables.

Connecting leads and electric animal fence wires shall not cross above overhead power or communication lines.

Crossings with overhead power lines shall be avoided wherever possible. If such a crossing cannot be avoided it shall be made underneath the power line and as nearly as possible at right angles to it.

If connecting leads and electric animal fence wires are installed near an overhead power line, the clearances shall not be less than those shown in the table below.

Minimum clearances from power lines for electric animal fences

Power line voltage	Clearance
≤1000 V	3 m (10')
>1000 V to ≤33,000 V	4 m (13')
>33,000 V	8 m (27')

If connecting leads and electric animal fence wires are installed near an overhead power line, their height above the ground shall not exceed 3 m (10'). This height applies to either side of the orthogonal projection of the outermost conductors of the power line on the ground surface, for a distance of:

- 2 m (6'6") for power lines operating at a nominal voltage not exceeding 1000 V.
- 15 m (50') for power lines operating at a nominal voltage exceeding 1000 V.

Electric animal fences intended for deterring birds, household pet containment or training animals such as cows need only be supplied from low output energizers to obtain satisfactory and safe performance.

In electric animal fences intended for deterring birds from roosting on buildings, no electric fence wire shall be connected to the energizer earth electrode. A warning sign shall be fitted to every point where persons may gain ready access to the conductors.

Where an electric animal fence crosses a public pathway, a non-electrified gate shall be incorporated in the electric animal fence at that point or a crossing by means of stiles shall be provided. At any such crossing, the adjacent electrified wires shall carry warning signs.

Any part of an electric animal fence that is installed along a public road or pathway shall be identified at frequent intervals by warning signs securely fastened to the fence posts or firmly clamped to the fence wires.

- The size of the warning sign shall be at least 100x200 mm (4x8").
- The background colour of both sides of the warning sign shall be yellow. The inscription on the sign shall be black and shall be either:

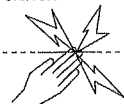

or the substance of "CAUTION: Electric animal fence".

- The inscription shall be indelible, inscribed on both sides of the warning sign and have a height of at least 25 mm (1").

Ensure that all mains-operated, ancillary equipment connected to the electric animal fence circuit provides a degree of isolation between the fence circuit and the supply mains equivalent to that provided by the energizer.

Protection from the weather shall be provided for the ancillary equipment unless this equipment is certified by the manufacturer as being suitable for use outdoors, and is of a type with a minimum degree of protection IPX4.

Frequently asked questions/Troubleshooting

What voltage is required to control animals?

4 kV is widely accepted as the recommended minimum voltage to control animals. However, you also require a well constructed fence system to ensure that animals cannot push through electrified wires.

The fence voltage is below 4 kV. How do I increase the voltage?

Check the energizer. Ensure that the energizer is on and set to operate at full power. Disconnect the fence wire from the energizer's fence output terminal. Measure the voltage across the energizer terminals using a Fault Finder, Digital Voltmeter or a remote control handset. If the voltage is less than 6 kV, the energizer may require servicing.

Check the energizer earthing. Use the procedure described in *Installing and testing an earth system* on page 6.

Check your fence system for faults. The most common source of low voltage is faults on the fence line.

If the fence, earth and energizer are in good condition and the voltage is still below 4 kV, talk to your nearest reseller. Recent extensions to your fence, a poor fence layout, or soil conditions may be causing inadequate voltage.

How do I locate faults?

The recommended tool for locating faults is a Fault Finder or remote control handset. These have a combined voltage and current meter which allows you to rapidly locate sources of current leakage. Alternatively, use a Digital Voltmeter. Use cut-out switches to turn off the power to different sections of the farm. If the voltage on the fence increases when a section of the farm is turned off, then investigate that section for possible faults.

There are no lights flashing on the energizer.

Ensure the power supply is on. Check the fence system for faults (see above). Check the energizer (see above). If the energizer still does not operate, it may require servicing.

The energizer does not respond to commands from the Remote Control Handset.

- Ensure that the remote contact on the Remote Control Handset is in contact with the fence wire before pressing **ON** or **OFF**. (Holding the button down for an extended period will not make the remote control work better.) After pressing **ON** or **OFF**, wait for two seconds for the ON or OFF message to disappear from the display, as the energizer may send out a final pulse after receiving the signal to deactivate. Similarly, allow two seconds for the energizer to send out its first pulse after receiving the command to reactivate.
- If the  symbol is displayed on the Remote Control Handset, replace the 9 V alkaline battery and try again.
- Rusty or oxidised wire can hamper the quality of the signal you receive. To obtain a clear signal, rub the Remote contact against the fence wire to break through the layer of rust or oxidation.
- Ensure that no spring gates or cut-out switches have been left open. Sometimes the remote control will work in spite of minor breaks in the wire, although reliable operation under such conditions is not guaranteed.
- Check for spark gaps and loose wire joints in the fence. Severe or multiple spark gaps reduce the effectiveness of the remote control.
- Use the fault finding function to locate faults in the fence line. See *Using the fault finder* on page 3.
- Check all connections to the fence and the earth system. Ensure that the energizer is connected to the power supply and the fence system and that the energizer is switched on.
- Try turning the energizer on and off by holding the Remote contact against the lead-out wire, or by holding the remote

control close to the energizer (within 150 to 300 mm [6 to 12"]). If the energizer still doesn't respond, then the remote control and energizer may have different address settings. See *Changing the energizer's address setting* on page 5 and *Activating the remote control function of an energizer supplied without a Remote Control Handset* on page 5.

The energizer sometimes turns off unexpectedly

- An adjacent property may have an energizer operating at the same address setting. Change the energizer's address setting. See *Changing the energizer's address setting* on page 5. If the problem persists, seek advice from your nearest reseller.

Identifying faults using the LED display

What do the light sequences on the LED display mean?

Different light sequences indicate different things. But there are certain light sequences that you must pay attention to more than others.

If...	This means that...
At each pulse, you see only red lights (no green lights).	The fence may be heavily loaded [voltage below or around 3 kV (3000 V)], Look for faults, e.g. short circuit or arcing faults. If no faults can be found, disconnect the energizer from the fence to see if the green lights illuminate on the energizer. If the green lights are visible, then the energizer is operating normally. This may indicate that the energizer is not sufficient for the length of the fence. Try subdividing the fence.
The 10th light segment flashes rapidly, a few other light segments are illuminated, and the energizer doesn't work.	The energizer has diagnosed a fault and should be returned to the service centre for repair.

If...	This means that...
The 10th light segment flashes rapidly, a few other light segments are illuminated, but the energizer resumes pulsing after some time, and this happens quite often.	The energizer has diagnosed a fault and should be returned to the service centre as soon as possible.
The 10th light segment flashes rapidly, and the 3rd and 6th light segments are illuminated.	The energizer is too hot to operate safely. This generally happens in places that experience high day-time temperatures. The energizer will resume normal operation when the temperature cools down sufficiently.
36 and 63 J energizers only - The energizer is pulsing, and the 10th light segment is illuminated.	The energizer has switched to the full-power mode, because there is a heavy load on the fence. See <i>Full-power mode (36 and 63 J energizers only)</i> on page 2 for more information.

Servicing

This energizer contains no user serviceable parts. It must be returned to a service agent appointed by Tru-Test Group for repair. If the supply cord is damaged it must only be replaced by service agent appointed by Tru-Test Group, as a special cord is required.

This energizer uses Double Insulation, where two systems of insulation are provided instead of grounding. No equipment grounding means is provided in the supply cord of a double-insulated energizer, nor should a means for equipment grounding be added to the energizer. Servicing a double-insulated energizer requires extreme care and knowledge of the system and should only be done by qualified service personnel. Replacement parts for a double-insulated energizer must be identical to the parts they replace. A double-insulated energizer is marked with the words DOUBLE INSULATION or DOUBLE INSULATED and/or the symbol below.



Product specifications

	20 J	36 J	63 J
Power Consumption	33 W	52 W	64 W
Maximum Output Voltage	up to 9500 V open circuit up to 8900 V at 500 Ω	up to 9400 V open circuit up to 8400 V at 500 Ω	up to 9500 V open circuit up to 8600 V at 500 Ω
Maximum Output Energy	up to 22.0 J at 50 Ω up to 7.3 J at 500 Ω	up to 36.5 J at 50 Ω up to 6.7 J at 500 Ω	up to 63.0 J at 25 Ω up to 7.0 J at 500 Ω
Stored Energy	34 J	54 J	97 J
Europe only	20 J	36 J	
Power Consumption	33 W	52 W	
Maximum Output Voltage	up to 7300 V open circuit up to 6400 V at 500 Ω	up to 7600 V open circuit up to 6600 V at 500 Ω	
Maximum Output Energy	up to 22.0 J at 50 Ω up to 4.8 J at 500 Ω	up to 36.5 J at 50 Ω up to 4.9 J at 500 Ω	
Stored Energy	34 J	54 J	

Values are typical and normal production tolerances of $\pm 10\%$ should be allowed for.

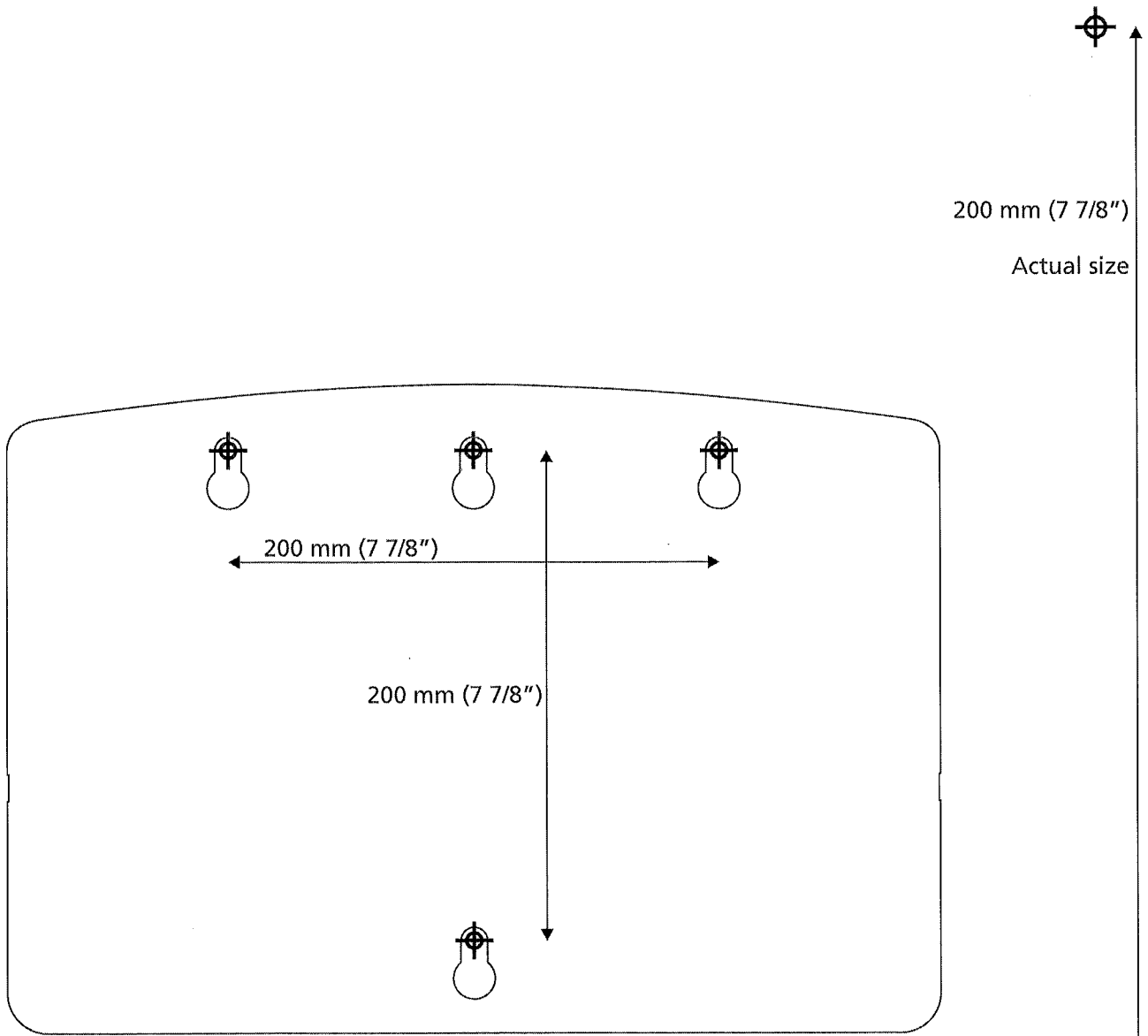

Diagram shown 40% of actual size

SAVE THESE INSTRUCTIONS